

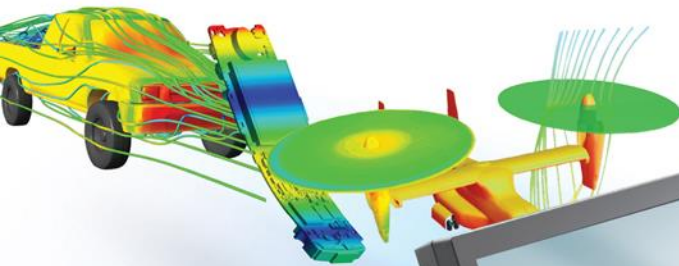

Influence of atmospheric streams on the dispersion of pollutant gases in urban areas



Prof.dr.ing. Florin POPESCU
Dr.ing. Răzvan MAHU
Prof.dr.ing. Ion Ion



UNIVERSITATEA
"DUNĂREA DE JOS"
DIN GALAȚI
FACULTATEA DE MECANICĂ

Dispersion în mediul urban



Numerical modeling and simulation – geometry

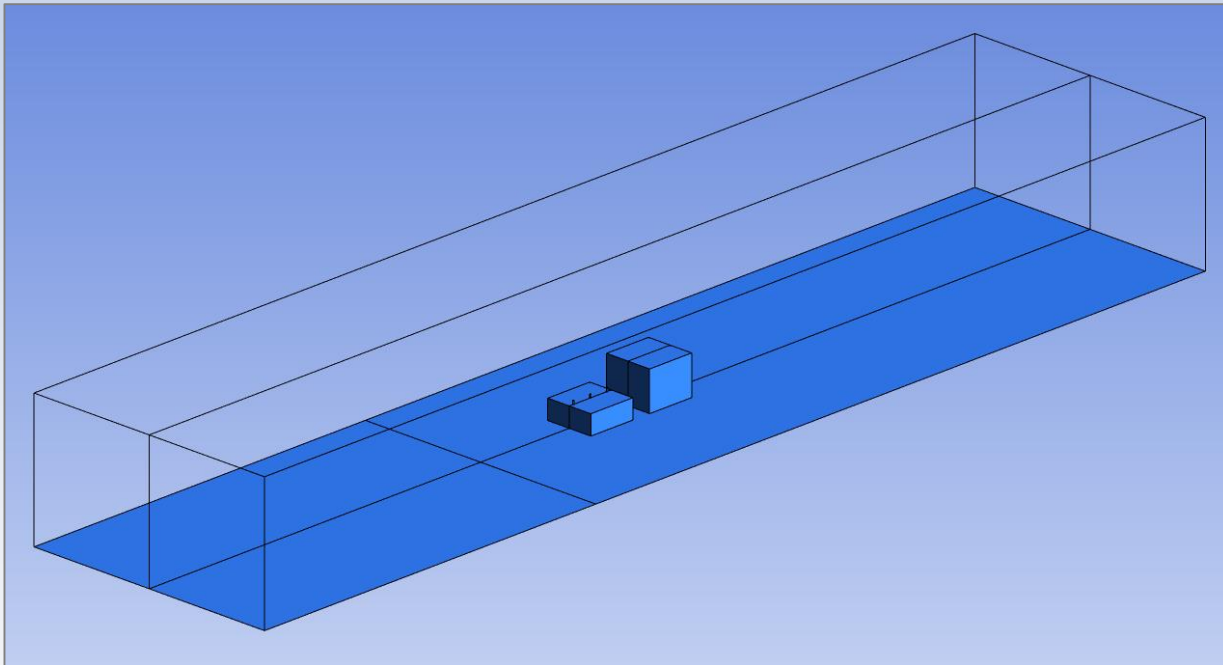

Numerical modeling and simulation – the mesh

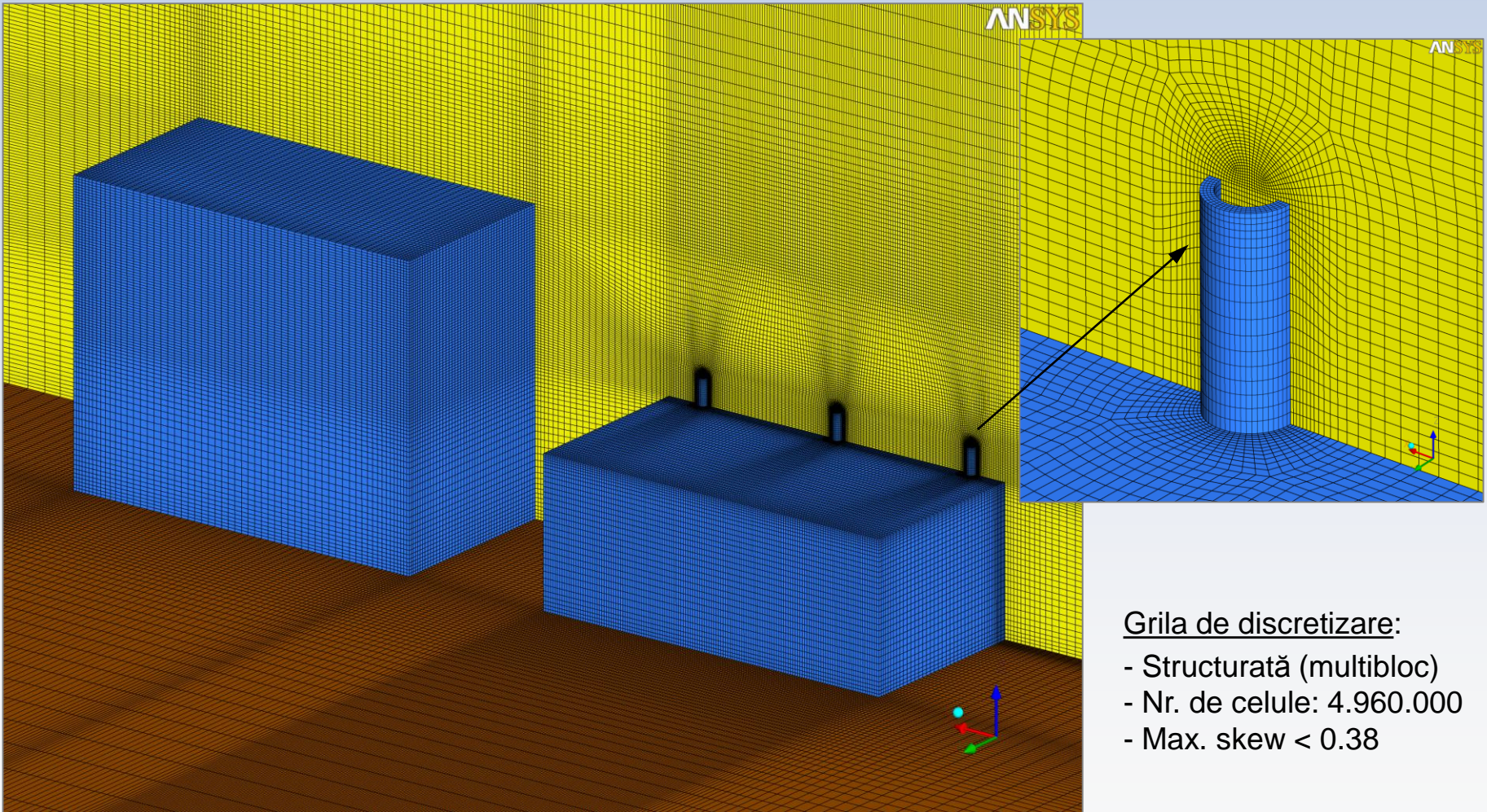

Grila de discretizare:

- Structurată (multibloc)
- Nr. de celule: 4.960.000
- Max. skew < 0.38

Results

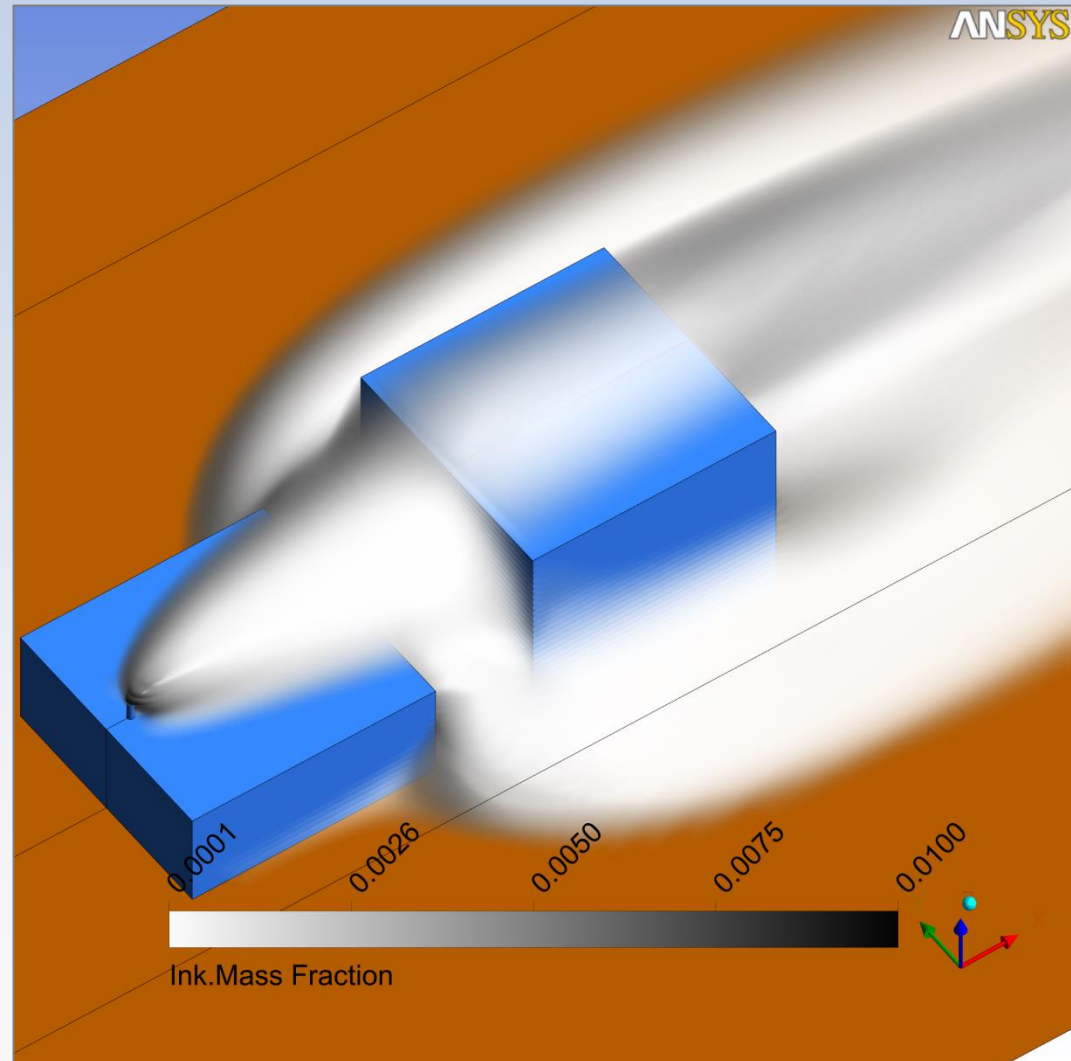

Results

ANSYS

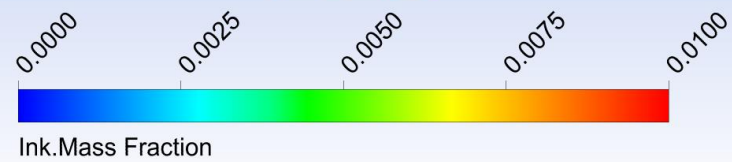

Results

ANSYS

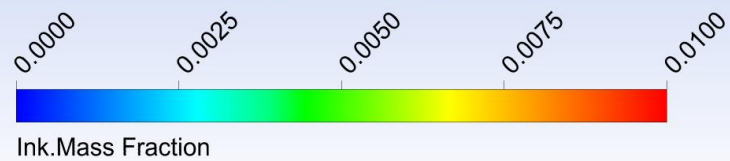

Results

ANSYS

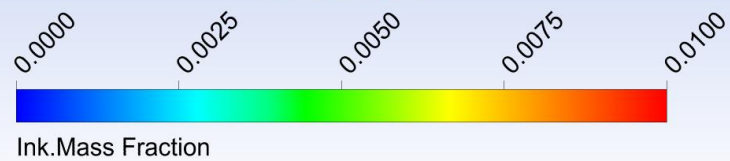

Results

ANSYS

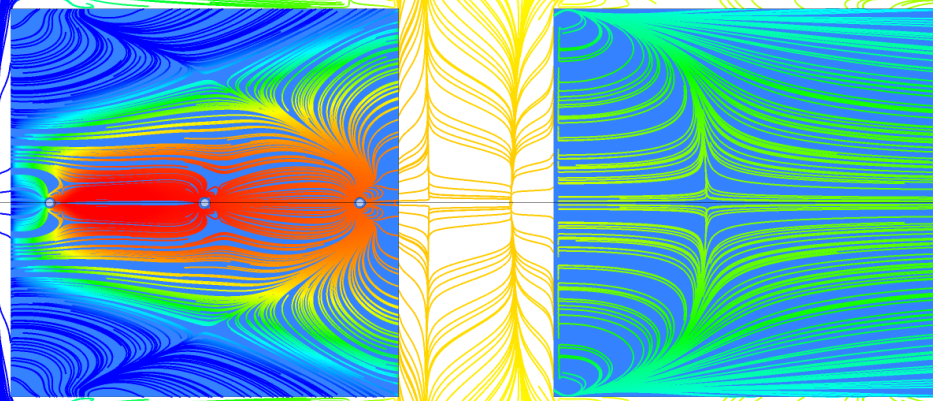

0.0000 0.0001 0.0003 0.0018 0.0100

Ink Mass Fraction



Results

ANSYS

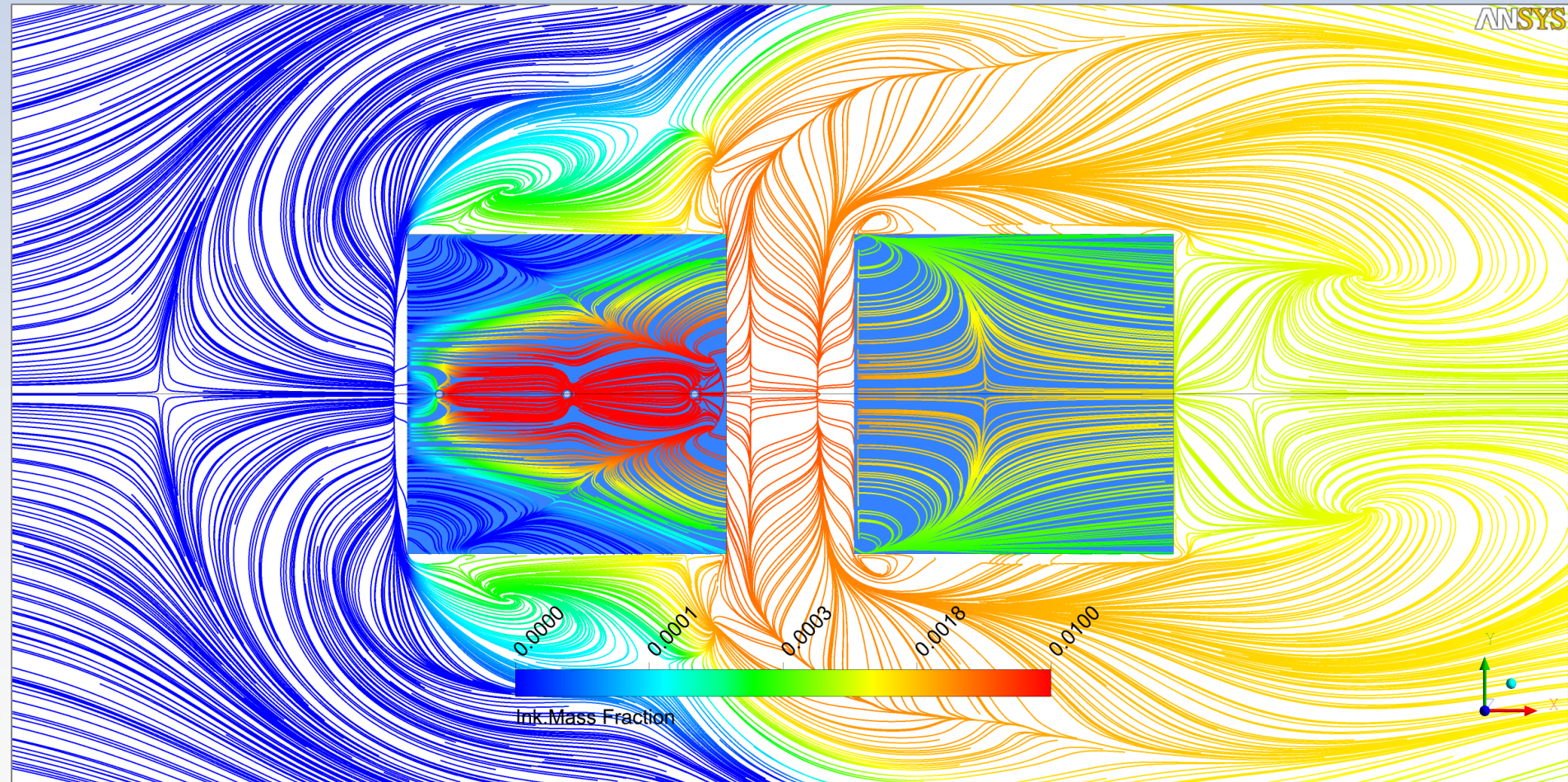

Results

ANSYS

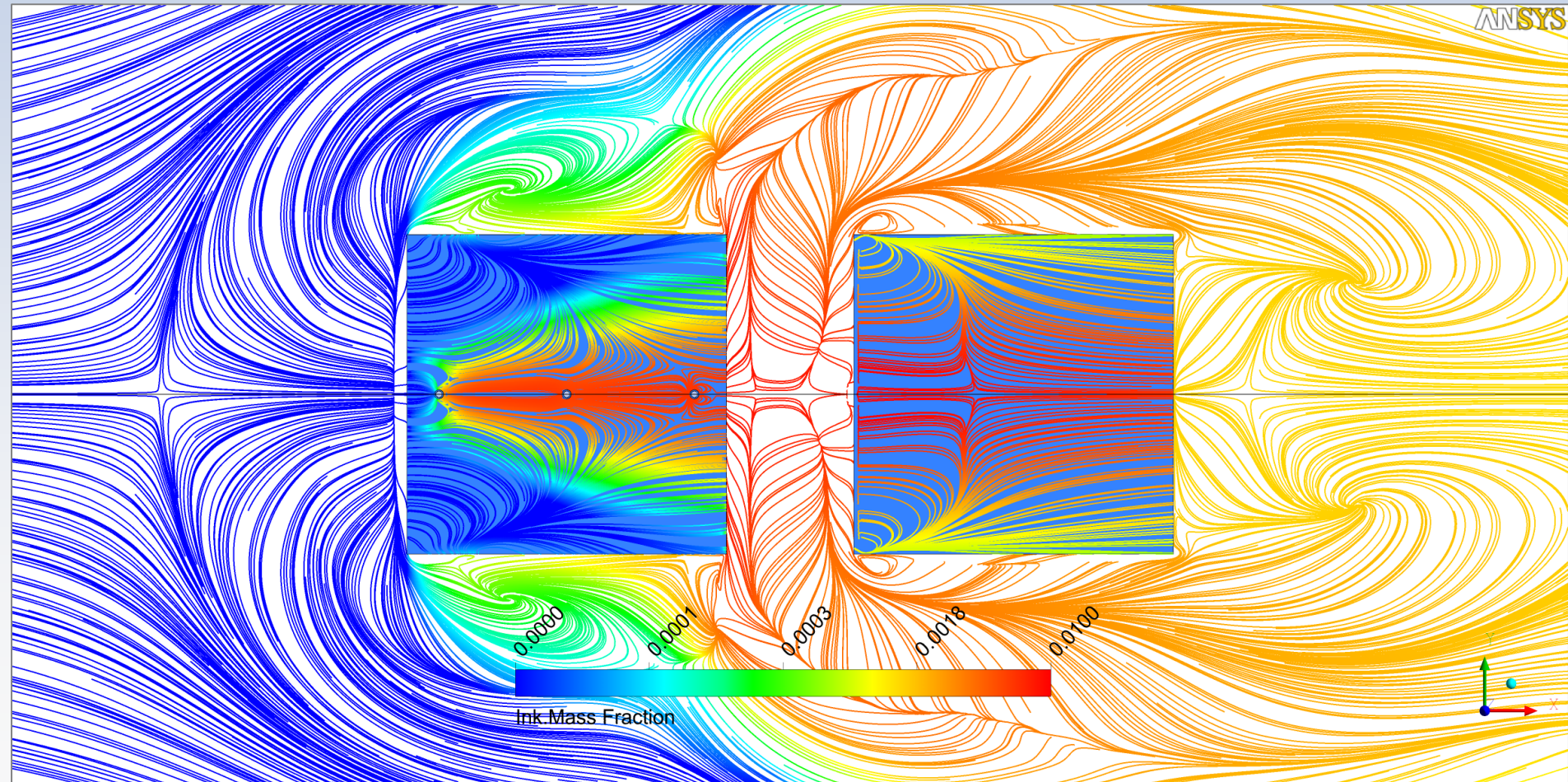

Results

ANSYS

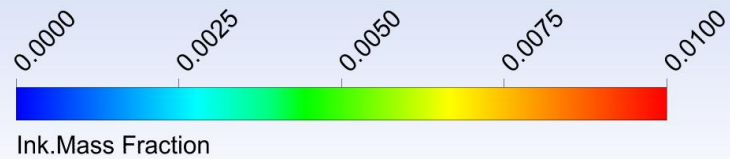

Rezultate (11)

ANSYS

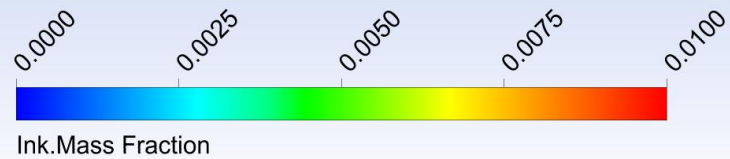

Results

ANSYS

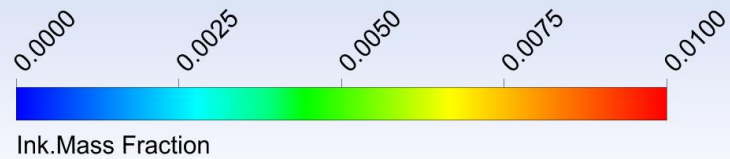

Results

ANSYS

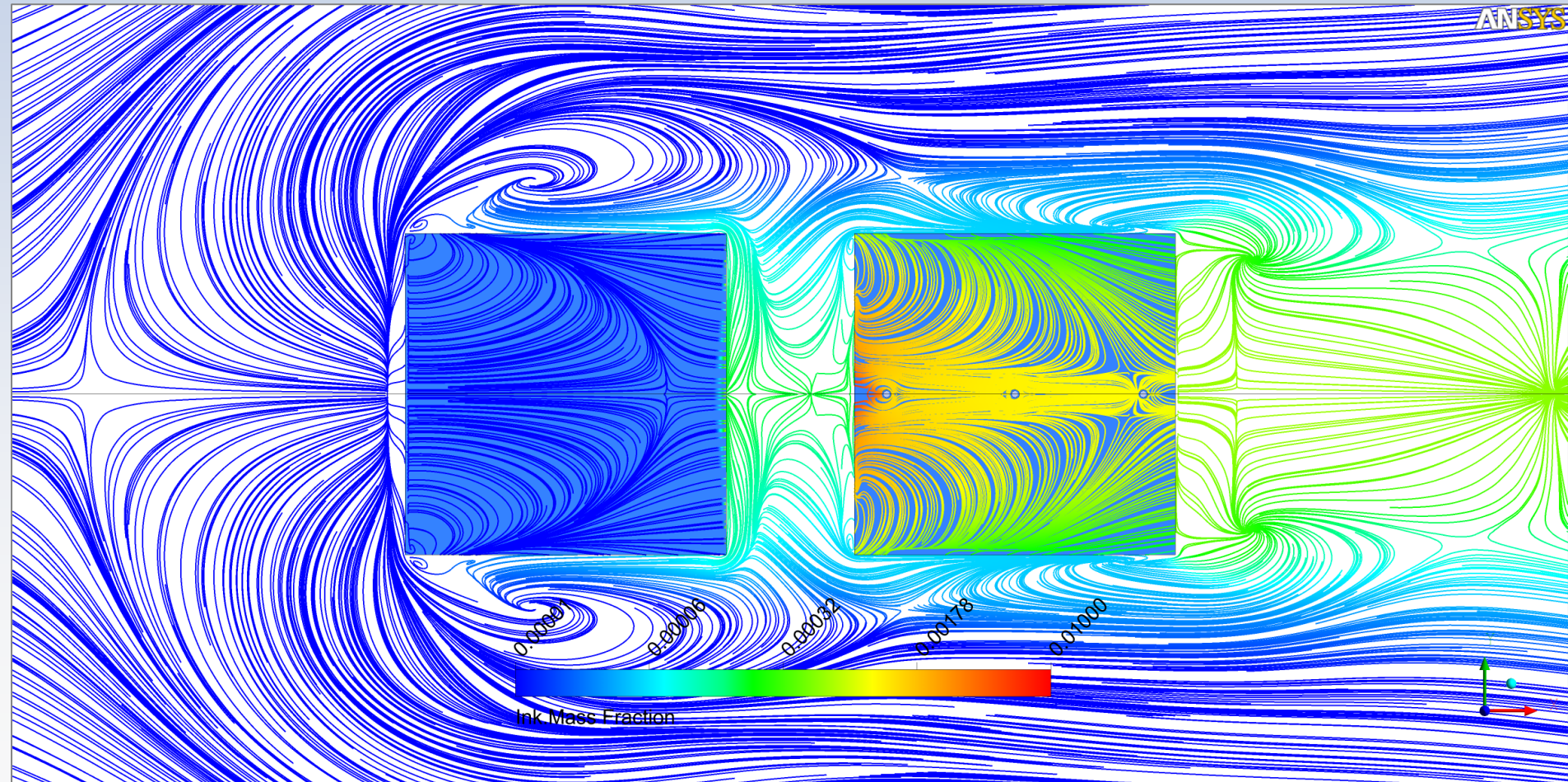

Results

ANSYS

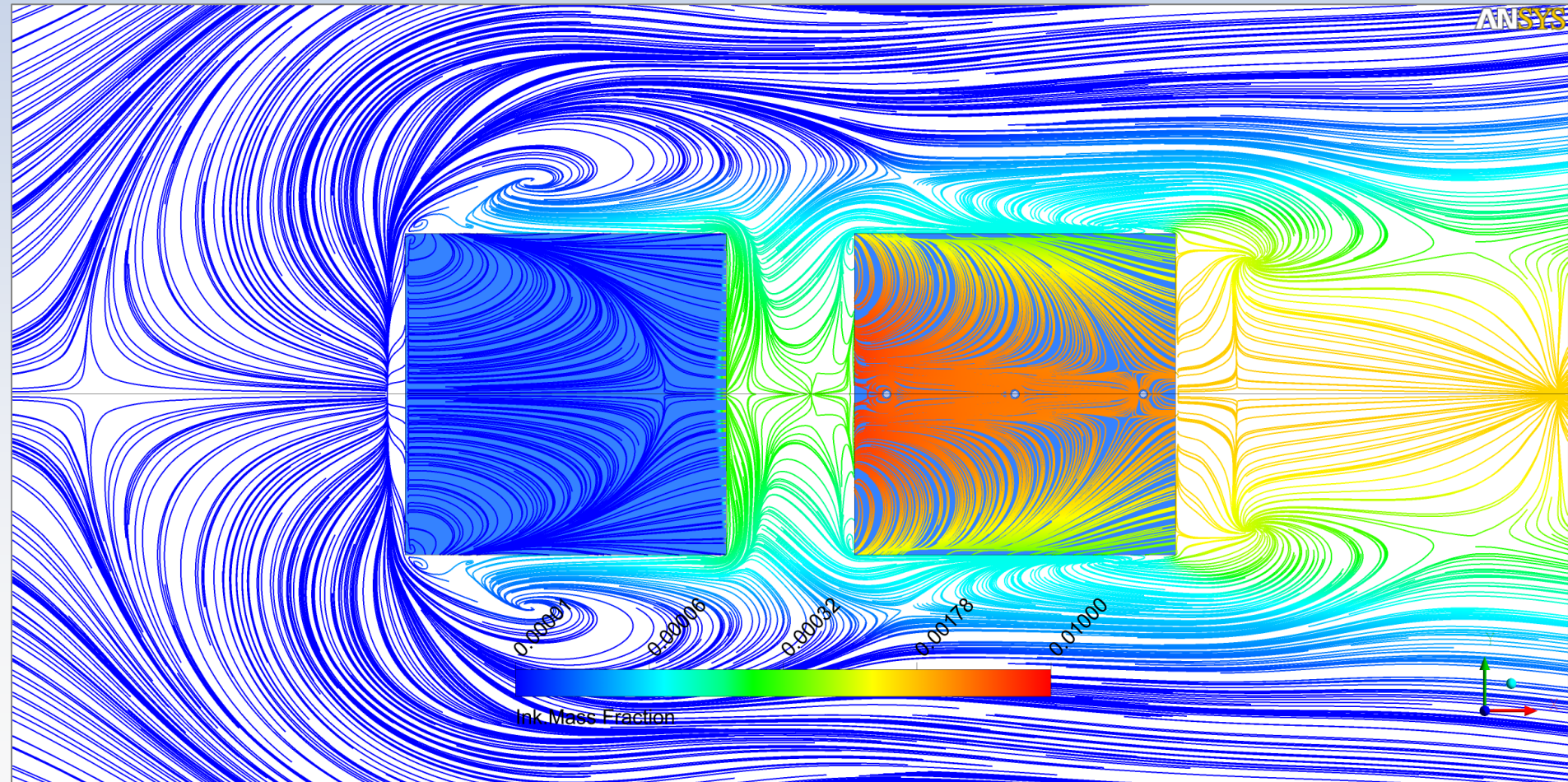

Results

ANSYS

